

Transient Voltage Suppressor

● Features

- IEC 61000-4-2(ESD)±30KV(air), ±25KV(contact)
- Low capacitance:0.35pF (Typical)
- Low clamping voltage
- Package optimized for high-speed lines
- Moisture sensitivity level: Level 1
- Ultra-small package: DFN1006-2L

Exterior

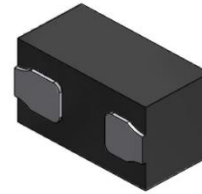

DFN1006-2L

Application Information

- Serial ATA
- Desktops, Servers and Notebooks
- Cellular Phones
- MDDI Ports
- USB2.0 Data Line Protection
- Display Ports
- HDMI

Package (top view)

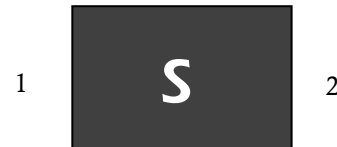

Agency Approvals

Icon	Description
RoHS	Compliance with 2011/65/EU
HF	Compliance with IEC61249-2-21:2003
	Mean lead free

Schematic Symbol

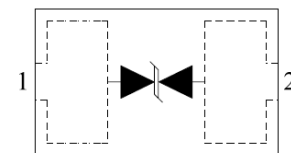

Part Number and Electrical Parameter

Part Number	I _{DRM} @V _{DRM}		V _{BR} @I _R		V _c @I _{pp} ^①		V _c @I _{pp} ^①		Co ^②	Co ^②
	μA	V	V	mA	V	A	V	A	pF	pF
	MAX		MIN		MAX		MAX		TYP	MAX
BV-FA05UC	1.0	5.0	6.0	1	12	1	14	2	0.35	0.50

Absolute maximum ratings measured at T= 25°C RH = 45%-75% (unless otherwise noted).

①Surge Waveform: 8/20μS.

②Off-state capacitance is measured in V_{DC}=0V, f=1MHz

Transient Voltage Suppressor

Part Numbering System

Mark

BV FA 05 U C
(1) (2) (3) (4) (5)

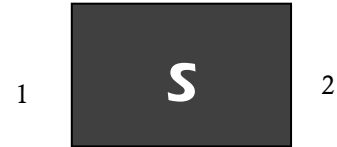

S: Part Number

- (1) Bencent Transient Voltage Suppressor
- (2) Package: DFN1006
- (3) Stand-off Voltage: 5V
- (4) Low Capacitance
- (5) Bi-directional

V-I Curve

Parameters	Definition
V_C	Clamping voltage
I_{PP}	Peak pulse current
V_{DRM}	Stand-off Voltage
V_{BR}	Breakdown Voltage
I_{DRM}	Reverse Leakage Current
I_R	Test current
P_{pp}	Peak Pulse Power Dissipation

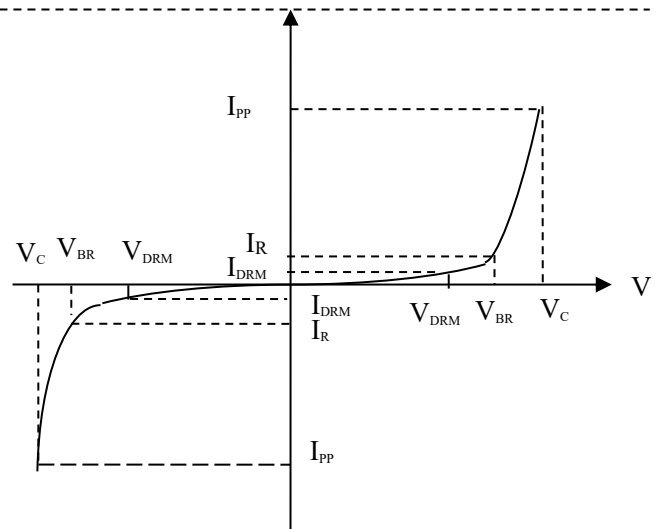

Typical Characteristics

Capacitance vs. Reverse Voltage

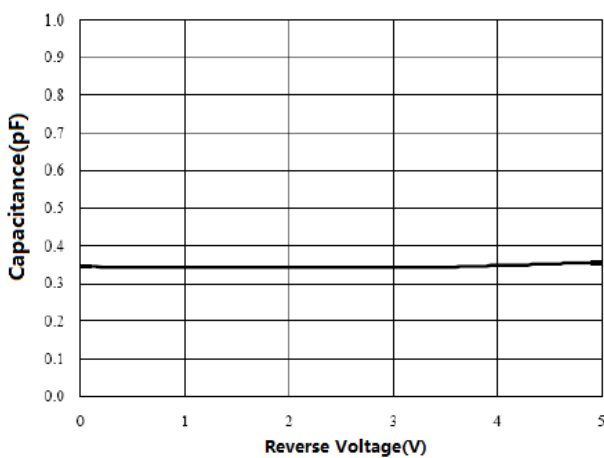

ESD Clamping of I/O to I/O(+8KV contact per IEC 61000-4-2)

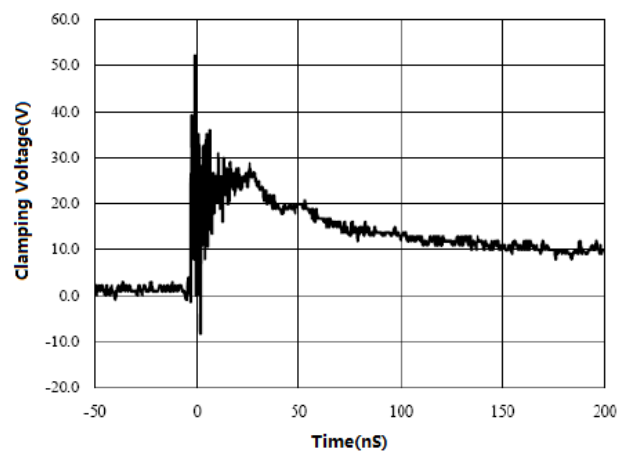

Transient Voltage Suppressor

Version: A2 2020-08-26

Thermal Considerations

symbol	Parameter	Value	Unit
T_j	Operating Junction Temperature Range	-55 to+125	°C
T_s	Storage Temperature Range	-55 to+150	°C

Environmental Characteristics

Testing items	Technical standards
HAST	Temperature: $130\pm 2^\circ\text{C}$ Bias= $80\%V_{\text{DRM}}$ Humidity: $85\pm 5\%$ Time:96H
High Temperature Storage Test	Temperature: 150°C Time:168H
High-low Temperature Cycle test	Temperature: From -40°C to 125°C Dwell time : 30min,100cycles
High Temperature &High Humidity Test	Temperature: 85°C Humidity:85% Time:168H
Pressure cooker Test	Temperature: 121°C , 2atm. Humidity:100% Time:24H
Resistance of soldering heat	Temperature: $260\pm 5^\circ\text{C}$ Time of dip soldering: 10s, 3times

Note: The above testing items can be specified by customer's special request

Product Dimensions

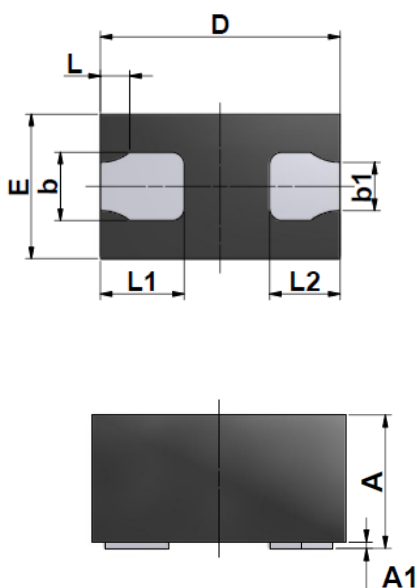

REF	mm	inch
A	0.450-0.550	0.0177-0.0217
A1	0.000-0.050	0.000-0.0020
D	0.950-1.050	0.0374-0.0413
E	0.550-0.650	0.0217-0.0256
b	0.275-0.295	0.0108-0.0116
b1	0.190-0.210	0.0075-0.0083
L	0.095-0.105	0.0037-0.0041
L1	0.330-0.370	0.0130-0.0146
L2	0.280-0.320	0.0110-0.0126

Transient Voltage Suppressor

Recommended Soldering Pad

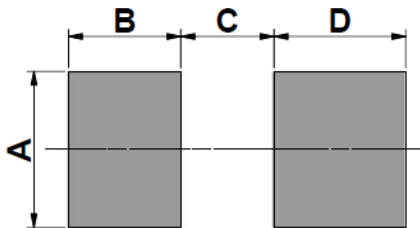

REF	mm	inch
A	0.60	0.024
B	0.55	0.022
C	0.30	0.012
D	0.55	0.022

Reflow Profile

Reflow Condition		Pb-Free assembly
Pre Heat	Temperature Min	150°C
	Temperature Max	200°C
	Time (Min to Max)	60 – 180 secs
Average ramp up rate (Liquid) T _{amp} (T _L) to peak		3°C/s Max
T _{s(max)} to T _L - Ramp-up Rate		3°C/s Max
Reflow	- Temperature (T _L) (Liquid)	217°C
	- Temperature (T _L)	60 – 150 secs
Peak Temperature (T _P)		260+0/-5 °C
Time within 5°C of actual peak Temperature (T _P)		30secs
Ramp-down Rate		6°C/s Max
Time 25°C to peak Temperature (T _P)		8 mins Max.
Do not exceed		260°C

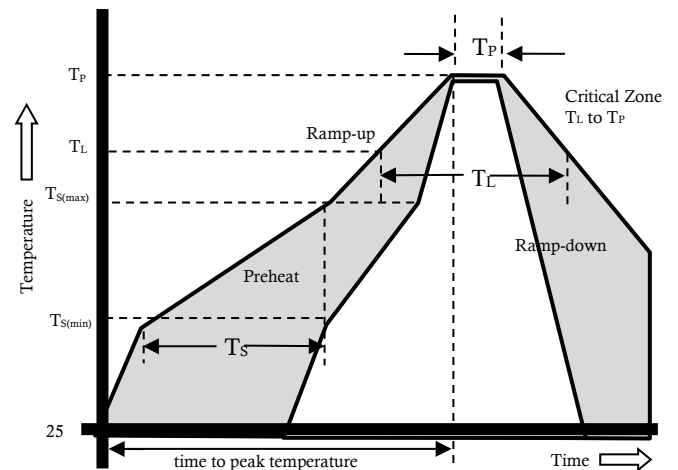

Package Reel Information

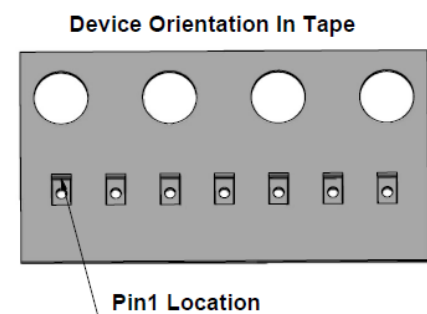
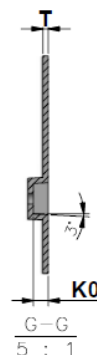
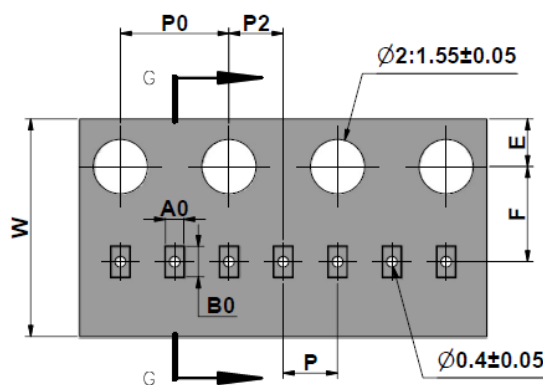

Transient Voltage Suppressor

Version: A2 2020-08-26

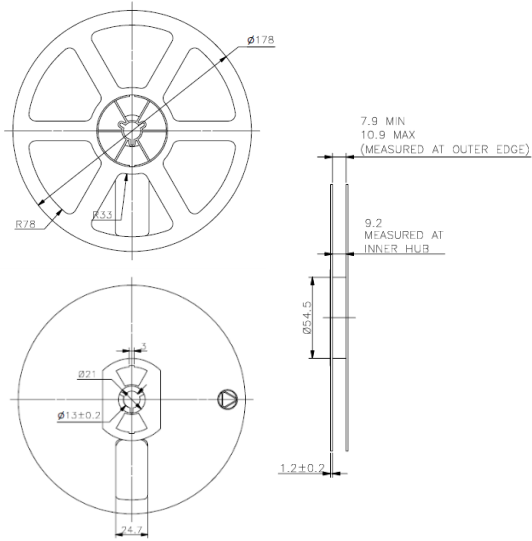

REF	mm	inch
A0	0.70 ± 0.10	0.028 ± 0.004
B0	1.15 ± 0.10	0.045 ± 0.004
K0	0.55 ± 0.05	0.022 ± 0.002
T	0.22 ± 0.05	0.009 ± 0.002
P	2.00 ± 0.10	0.079 ± 0.004
P0	4.00 ± 0.10	0.157 ± 0.004
P2	2.00 ± 0.10	0.079 ± 0.004
E	1.75 ± 0.10	0.069 ± 0.004
F	3.50 ± 0.10	0.138 ± 0.004
W	8.00 ± 0.20	0.315 ± 0.008

OUTLINE	REEL (PCS)	PER CARTON (PCS)	REEL DIAMETERS (mm)	CARTON SIZE(mm)		
				L	W	H
TAPING	10,000	300,000	178	390	370	220