

Transient Voltage Suppressor

Features

- IEC 61000-4-2(ESD)±15KV(air), ±8KV(contact)
- 150Watts peak pulse power (tp=8/20μS)
- Ultra low capacitance: 0.8pF typical
- Low clamping voltage
- Moisture sensitivity level: Level 1
- Weight 5.0 mg
- Small package: SOD-323

Exterior

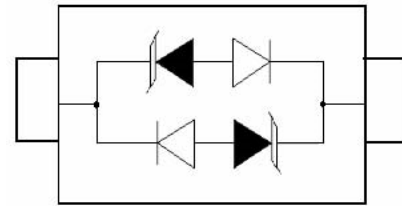

SOD-323

Application Information

- xDSL secondary

Agency Approvals

Icon	Description
RoHS	Compliance with 2011/65/EU
HF	Compliance with IEC61249-2-21:2003
	Mean lead free

Part Number and Electrical Parameter

Part Number	I _{DRM} @V _{DRM}		V _{BR} ^① @I _R		V _c @I _{pp} ^②		V _c @I _{pp} ^②		Co ^③	
	μA	V	V	mA	V	A	V	A	pF	
	MAX		MIN		MAX		MAX		TYP	MAX
BV15C	1	15	16.7	1	24	1	31.8	5	0.8	1.5

Absolute maximum ratings measured at T= 25°C RH = 45%-75% (unless otherwise noted).

① V_{BR} is measured at I_R=1mA

② Surge Waveform: 8/20 μ S.

③ Off-state capacitance is measured in V_{DC}=0V, V_{RMS}=1V, f=1MHz

Part Numbering System

BV 15 C
(1) (2) (3)

- (1) Bencent Transient Voltage Suppressor
(2) Stand-state Voltage, e.g. 15=15V
(3) Polarity: Bi-direction

Mark



EC: Part Number

Transient Voltage Suppressor

V-I Curve

Parameters	Definition
V_C	Clamping Voltage
I_{PP}	Surge Waveform 8/20 μ s
V_{DRM}	Stand-off Voltage
V_{BR}	Breakdown Voltage
I_{DRM}	Reverse Leakage Current
I_R	Test Current
P_{pp}	Peak Pulse Power Dissipation

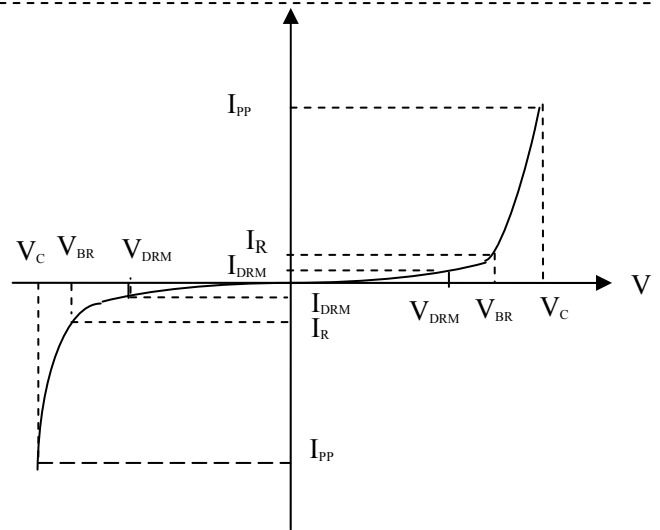

Thermal Considerations

symbol	Parameter	Value	Unit
T_J	Operating Junction Temperature Range	-55 to +150	$^{\circ}$ C
T_S	Storage Temperature Range	-55 to +150	$^{\circ}$ C

Environmental Characteristics

Testing items	Technical standards
High Temperature Reverse Bias Test	Temperature: $150 \pm 3^{\circ}$ C Bias= $80\%V_{DRM}$ Time:168H
High Temperature Life Test	Temperature: 150° C Time:168H
High-low Temperature Cycle Test	Temperature: From -40° C to 125° C Dwell time : 30min,10cycles
High Temperature &High Humidity Test	Temperature: 85° C Humidity:85% Time:168H
Pressure Cooker Test	Temperature: 121° C, 2atm. Humidity:100% Time:24H
Resistance of Soldering Heat	Temperature: $260 \pm 5^{\circ}$ C Time of dip soldering: 10s, 3times

Note: The above testing items can be specified by customer's special request

Transient Voltage Suppressor

Version: A2 2016-08-15

Product Dimensions

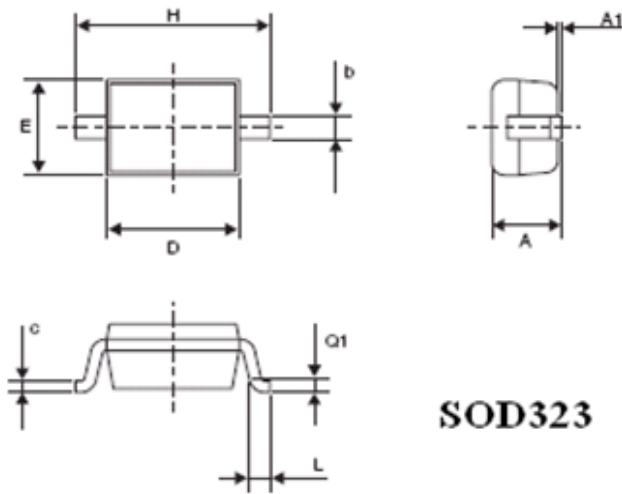

SOD323

REF	mm	inch
A	1.17(max)	0.046(max)
A1	0.10(max)	0.004(max)
b	0.34±0.10	0.013±0.0039
c	0.17±0.08	0.007±0.0032
D	1.66±0.14	0.065±0.0055
E	1.28±0.17	0.050±0.0067
H	2.5±0.2	0.098±0.0079
L	0.28±0.18	0.011±0.0071
Q1	0.25±0.15	0.010±0.0059

Recommended Soldering Pad

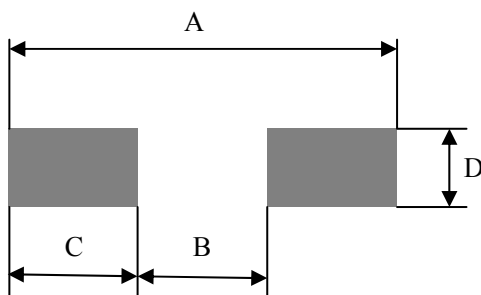

REF	mm	inch
A	3.20	0.126
B	1.08	0.043
C	1.06	0.042
D	0.54	0.021

Reflow Profile

Reflow Condition		Pb-Free Assembly
Pre Heat	Temperature Min.	+150°C
	Temperature Max.	+200°C
	Time(Min to Max)	60 – 180 secs.
Average ramp up rate(Liquidus Temp(T_L) to peak)		3°C/sec. Max.
Ts(max) to T_L - Ramp-up Rate		3°C/sec. Max.
Reflow	- Temperature (T_L) (Liquidus)	+217°C
	- Temperature (T_L)	60 – 150 secs.
Peak Temp (T_P)		+(260±0/-5)°C
Time within 5°C of actual Peak Temp (T_P)		25 secs.
Ramp-down Rate		6°C/sec. Max.
Time 25°C to peak Temp (T_P)		8 min. Max.
Do not exceed		+260°C

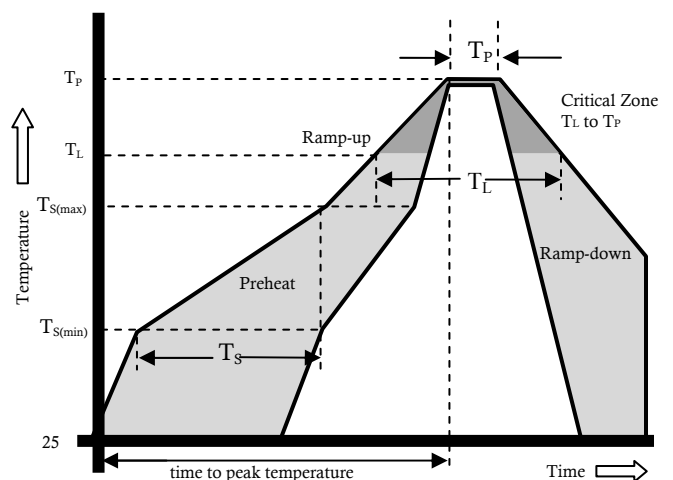

Transient Voltage Suppressor

Version: A2 2016-08-15

Package Reel Information

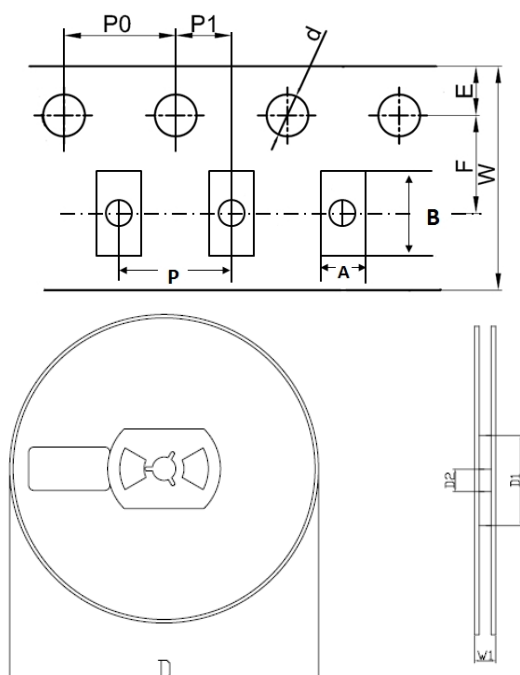

REF	mm	inch
A	1.46+/-0.1	0.057+/-0.004
B	3.10+/-0.3	0.122+/-0.012
d	1.50+/-0.1	0.059+/-0.004
D	178+/-1.0	7.008+/-0.039
D1	55+/-3	2.165+/-0.118
D2	13+/-0.5	0.512+/-0.020
E	1.75+/-0.1	0.069+/-0.004
F	3.5+/-0.2	0.138+/-0.008
P	4.0+/-0.2	0.157+/-0.008
P0	4.0+/-0.2	0.157+/-0.008
P1	2.0+/-0.2	0.079+/-0.008
W	8.0+/-0.2	0.315+/-0.008
W1	12.3+/-1.0	0.484+/-0.039

Outline	Reel (pcs)	Per Carton (pcs)	Reel Diameters (mm)	Carton Size(mm)		
				L	W	H
Taping	3,000	90,000	177	390	370	220